

SOT-23

SOT-23 Plastic-Encapsulate Transistors

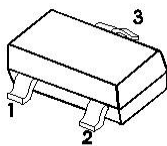

1. BASE
2. EMITTER
3. COLLECTOR

Marking:CR

特征 Features

与 A733 配对; Complementary to A733
最大功率耗散 200mW; Power Dissipation of 200mW
高稳定性和可靠性; High Stability and High Reliability

机械数据 Mechanical Data

封装: SOT-23 封装 SOT-23 Small Outline Plastic Package
环氧树脂 UL 易燃等级 Epoxy UL: 94V-0
安装位置: 任意 Mounting Position: Any

极限值和温度特性 (TA = 25°C 除非另有规定)

Maximum Ratings & Thermal Characteristics (Ratings at 25°C ambient temperature unless otherwise specified.)

参数 Parameters	符号 Symbol	数值 Value	单位 Unit
Collector-Base Voltage	V _{CBO}	60	V
Collector-Emitter Voltage	V _{CEO}	50	V
Emitter -Base Voltage	V _{EBO}	5	V
Collector Current-Continuous	I _C	150	mA
Collector Power Dissipation	P _C	200	mW
Junction Temperature	T _j	150	°C
Storage Temperature	T _{stg}	-55-+150	°C
Thermal resistance From junction to ambient	R _{θJA}	625	°C/W

电特性 (TA = 25°C 除非另有规定)

Electrical Characteristics (Ratings at 25°C ambient temperature unless otherwise specified.)

参数 Parameter	符号 Symbols	测试条件 Test Condition	界限 Limits		单位 Unit
			Min	Max	
Collector-base breakdown voltage	V(BR)CBO	IC=5uA, IE=0	60		V
Collector-emitter breakdown voltage	V(BR)CEO	IC=1mA, IB=0	50		V
Emitter-base breakdown voltage	V(BR)EBO	IE=10uA, IC=0	5		V
Collector cut-off current	ICBO	V _{CB} =60V, IE=0		100	nA
Emitter cut-off current	IEBO	V _{EB} =5V, IC=0		100	nA
DC current gain	hFE(1)*	V _{CE} =6V, IC=1mA	120	400	
Collector-emitter saturation voltage	V _{CE(sat)} I*	IC=100mA, IB=10mA		0.30	V
Base -emitter saturation voltage	V _{BE(sat)} *	IC=100mA, IB=10mA		1.10	V
Base-emitter voltage	V _{BE} *	V _{CE} =10V, IC=1A		1	V
Transition frequency	f _T	V _{CE} =10V, IC=50mA, f=30MHz	50		

*Pulse test: pulse width ≤ 300μs, duty cycle ≤ 2.0%.

Classification of hFE

RANK	L	H
RANGE	120-220	220-400

典型特性曲线 Typical characteristics

Static Characteristics

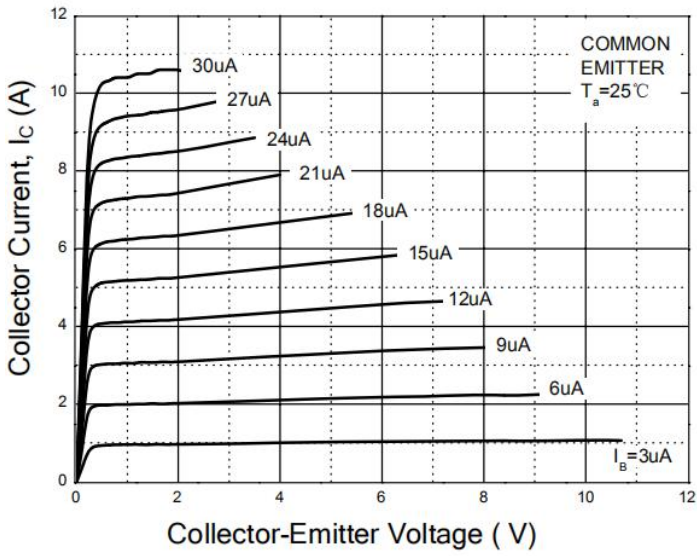

DC Current Gain

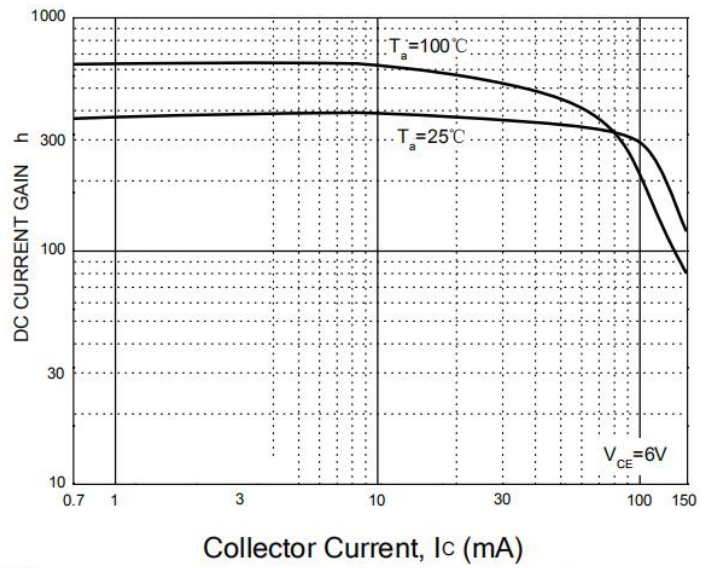

Saturation Voltage

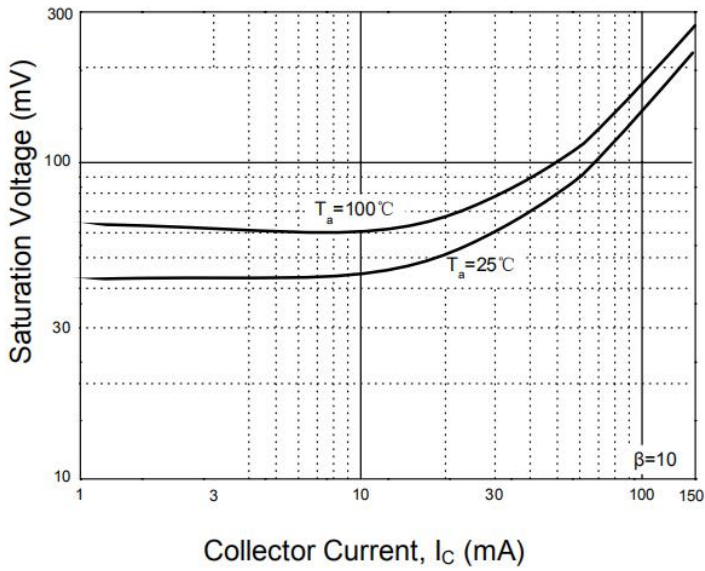

Current Gain-Bandwidth Product

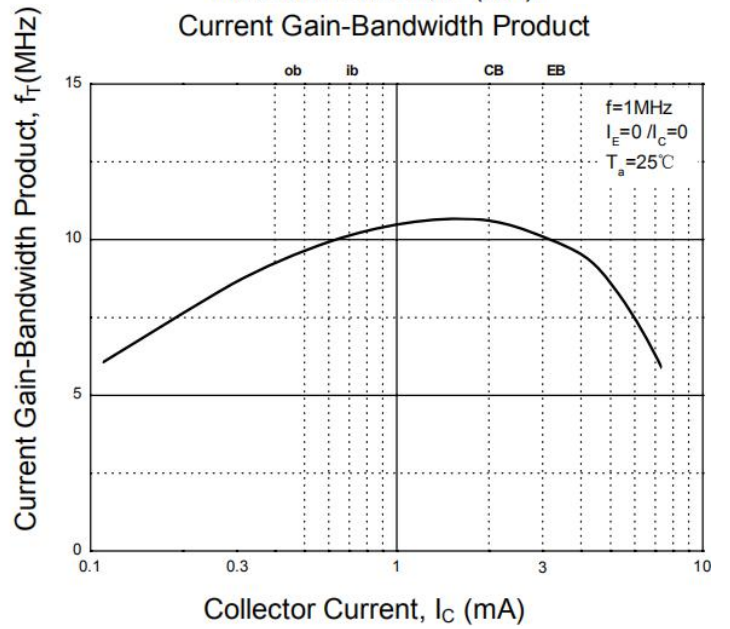

SOT-23 PACKAGE OUTLINE Plastic surface mounted package

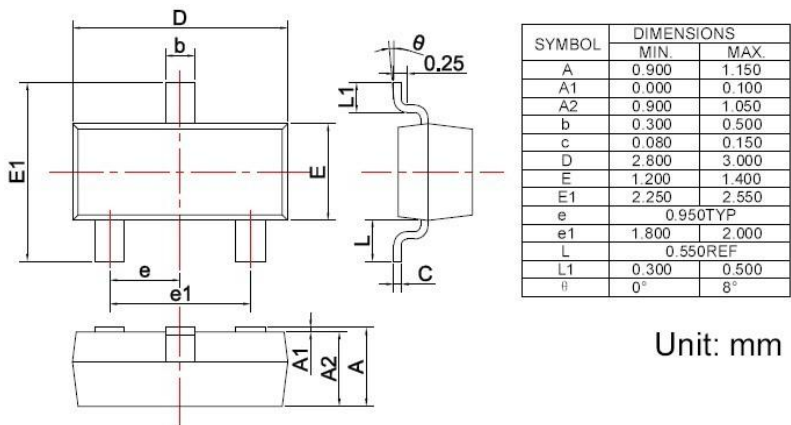

焊盘设计参考 Precautions: PCB Design

Recommended land dimensions for SOT-23 diode. Electrode patterns for PCBs

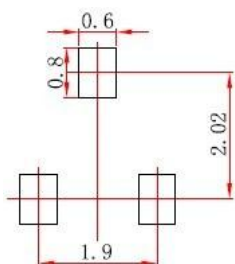

- Note:
1. Controlling dimension: In millimeters.
 2. General tolerance: ± 0.05mm.
 3. The pad layout is for reference purposes only.