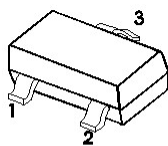

**SOT-23****SOT-23 贴片塑封三极管**  
**SOT-23 Plastic-Encapsulate Transistors**

1. BASE  
2. EMITTER  
3. COLLECTOR

Marking: 2T1

**特征 Features**

- 与 S9013 配对; Complementary to S9013
- 最大功率耗散 300mW; Power Dissipation of 300mW
- 高稳定性和可靠性。High Stability and High Reliability

**机械数据 Mechanical Data**

- 封装: SOT-23 封装 SOT-23 Small Outline Plastic Package
- 环氧树脂 UL 易燃等级 Epoxy UL: 94V-0
- 安装位置: 任意 Mounting Position: Any

极限值和温度特性(TA = 25°C 除非另有规定)

**Maximum Ratings & Thermal Characteristics** (Ratings at 25°C ambient temperature unless otherwise specified.)

参数 Parameters	符号 Symbol	数值 Value	单位 Unit
Collector-Base Voltage	V <sub>CBO</sub>	-40	V
Collector-Emitter Voltage	V <sub>CEO</sub>	-25	V
Emitter -Base Voltage	V <sub>EBO</sub>	-5	V
Collector Current-Continuous	I <sub>C</sub>	-500	mA
Collector Power Dissipation	P <sub>C</sub>	300	mW
Junction Temperature	T <sub>j</sub>	150	°C
Storage Temperature	T <sub>stg</sub>	-55-+150	°C
Thermal resistance From junction to ambient	R <sub>θJA</sub>	416	°C/W

电特性 (TA = 25°C 除非另有规定)

**Electrical Characteristics** (Ratings at 25°C ambient temperature unless otherwise specified.)

参数 Parameter	符号 Symbols	测试条件 Test Condition	界限 Limits		单位 Unit
			Min	Max	
Collector-base breakdown voltage	V(BR)CBO	I <sub>C</sub> =-100uA, I <sub>E</sub> =0	-40		V
Collector-emitter breakdown voltage	V(BR)CEO	I <sub>C</sub> =-1mA, I <sub>B</sub> =0	-25		V
Emitter-base breakdown voltage	V(BR)EBO	I <sub>E</sub> =-100uA, I <sub>C</sub> =0	-5		V
Collector cut-off current	I <sub>CEO</sub>	V <sub>CE</sub> =-20V, I <sub>B</sub> =0		-100	nA
Collector cut-off current	I <sub>CBO</sub>	V <sub>CB</sub> =-40V, I <sub>E</sub> =0		-100	nA
Emitter cut-off current	I <sub>EBO</sub>	V <sub>EB</sub> =-5V, I <sub>C</sub> =0		-100	nA
DC current gain	h <sub>FE</sub>	V <sub>CE</sub> =-1V, I <sub>C</sub> =-50mA	120	400	
Collector-emitter saturation voltage	V <sub>CE(sat)</sub>	I <sub>C</sub> =-500mA, I <sub>B</sub> =-50mA		-0.60	V
Base -emitter saturation voltage	V <sub>BE(sat)</sub>	I <sub>C</sub> =-500mA, I <sub>B</sub> =-50mA		-1.20	V
Transition frequency	f <sub>T</sub>	V <sub>CE</sub> =-6V, I <sub>C</sub> =-20mA, f=30MHz	150		MHz
Collector output capacitance	C <sub>ob</sub>	V <sub>CB</sub> =-10V, I <sub>E</sub> =0, f=1MHz		5	pF

**CLASSIFICATION OF h<sub>FE(1)</sub>**

RANK	L	H	J
RANGE	120-200	200-350	300-400

Typical characteristics

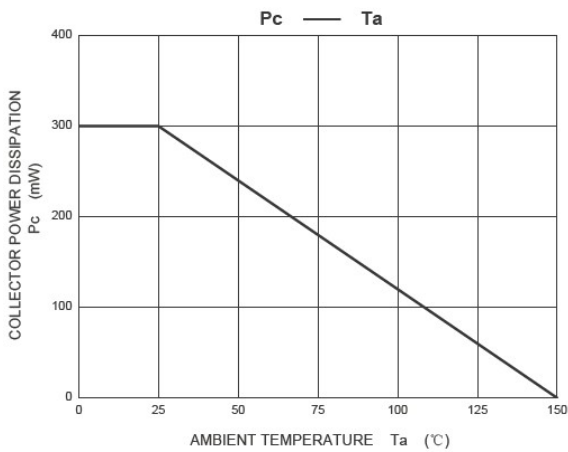
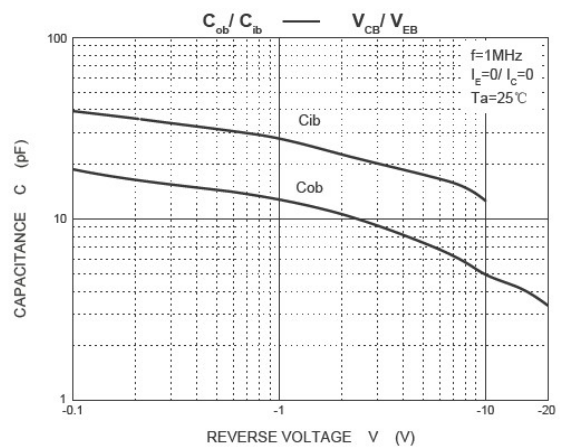
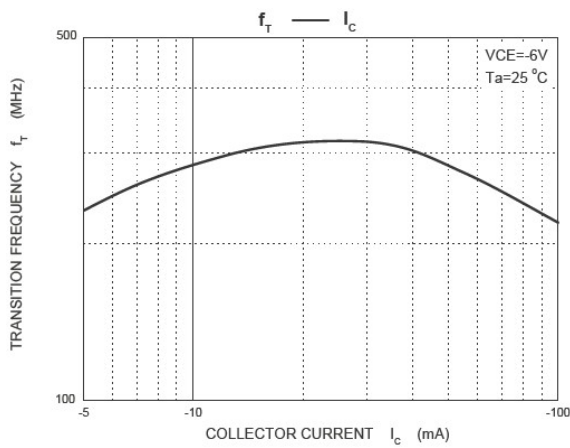
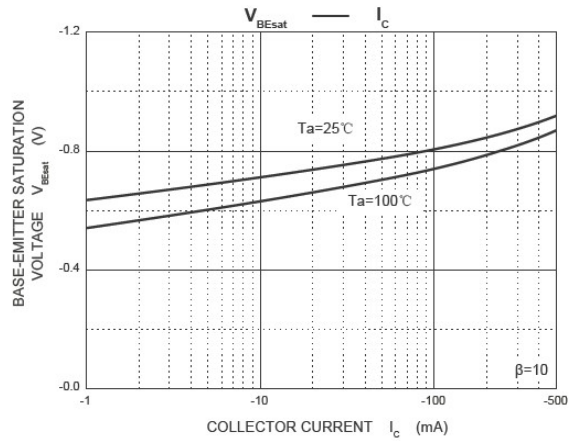
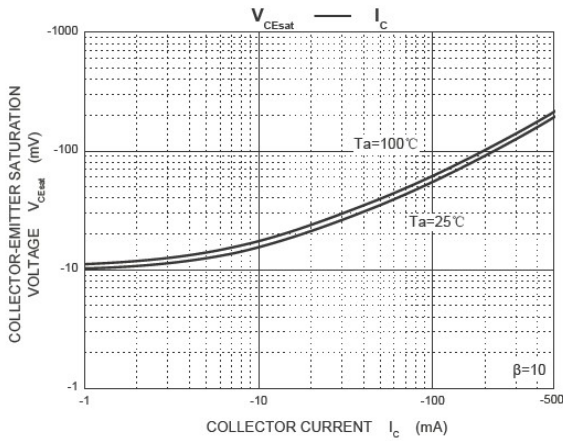
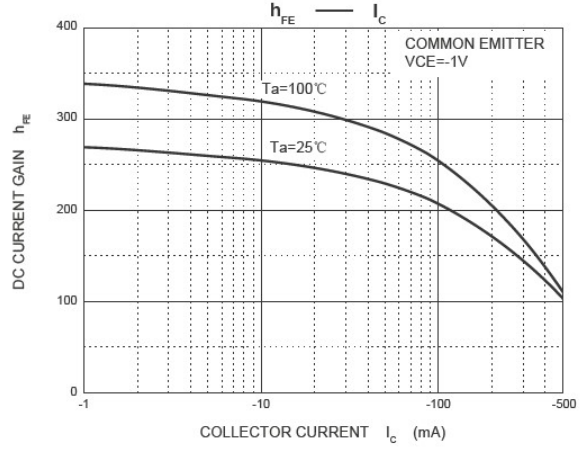
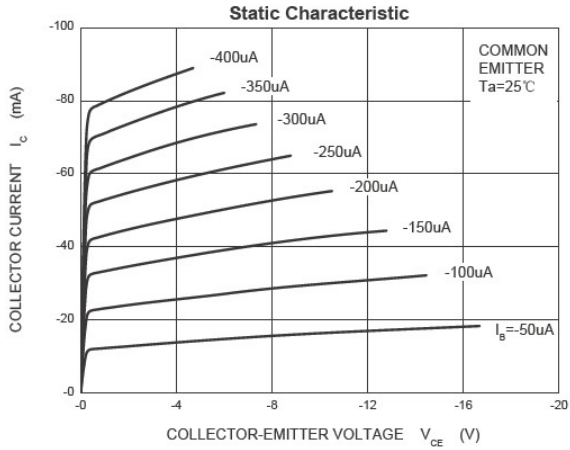

## SOT-23 PACKAGE OUTLINE Plastic surface mounted package

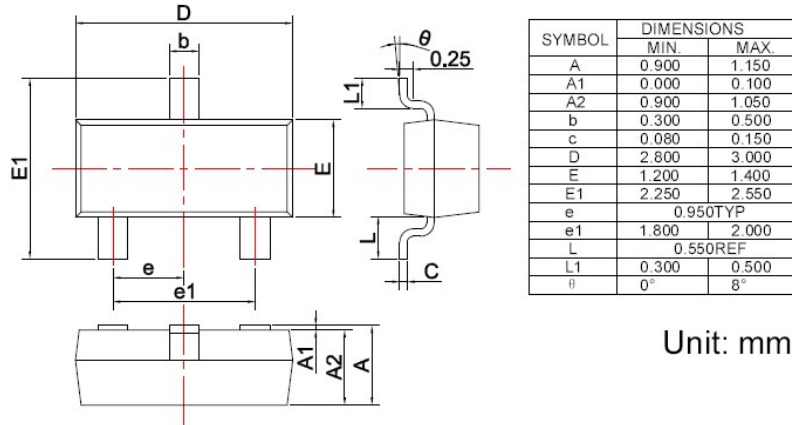

焊盘设计参考 Precautions: PCB Design

Recommended land dimensions for SOT-23 diode. Electrode patterns for PCBs

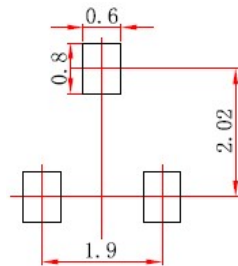

Note:

1. Controlling dimension; in millimeters.
2. General tolerance:  $\pm 0.05$ mm.
3. The pad layout is for reference purposes only.